



INSTYTUT TECHNIKI BUDOWLANEJ
PL 00-611 WARSZAWA
ul. Filtrowa 1
tel.: (+48 22) 825-04-71
(+48 22) 825-76-55
fax: (+48 22) 825-52-86
www.itb.pl



Member of



European Technical Assessment

**ETA-12/0272
of 29/06/2018**

General Part

Technical Assessment Body issuing the European Technical Assessment

Instytut Techniki Budowlanej

Trade name of the construction product

KPR-FAST, KPS-FAST,
KPR-STRONG and KPS-STRONG

Product family to which the construction product belongs

Plastic anchors for multiple use in concrete and masonry for non-structural applications

Manufacturer

KLIMAS Sp. z o.o.
ul. Wincentego Witosa 135/137
Kuźnica Kiedrzyńska
PL 42-233 Mykanów
Poland

Manufacturing plant

KLIMAS Sp. z o.o.
ul. Warszawska 2, Wanaty
PL 42-260 Kamienica Polska
Poland

This European Technical Assessment contains

33 pages including 3 Annexes which form an integral part of this Assessment

This European Technical Assessment is issued in accordance with regulation (EU) No 305/2011, on the basis of

Guideline for European Technical Approval of "Plastic anchors for multiple use in concrete and masonry for non-structural applications", ETAG 020, Edition March 2012 used as European Assessment Document (EAD)

This version replaces

ETA-12/0272 issued on 30/03/2017

This European Technical Assessment is issued by the Technical Assessment Body in its official language. Translations of this European Technical Assessment in other languages shall fully correspond to the original issued document and shall be identified as such.

Communication of this European Technical Assessment, including transmission by electronic means, shall be in full. However, partial reproduction may only be made with the written consent of the issuing Technical Assessment Body. Any partial reproduction has to be identified as such.

Specific Part

1 Technical description of the product

The KPR-FAST, KPS-FAST, KPR-STRONG and KPS-STRONG frame anchors are the anchors consisting of a plastic sleeve made of polyamide and an accompanying specific screw made of galvanised or stainless steel.

The plastic sleeve is expanded by screwing in the specific screw which presses the sleeve against the wall of the drilled hole.

The illustration and the description of the product are given in Annex A.

2 Specification of the intended use in accordance with the applicable European Assessment Document (EAD)

The performance given in Annex C are only valid if the anchor is used in compliance with the specifications and conditions given in Annex B.

The provisions made in this European Technical Assessment are based on an assumed working life of the anchor of 50 years. The indications given on the working life cannot be interpreted as a guarantee given by the producer or Technical Assessment Body, but are to be regarded only as a means for choosing the right products in relation to the expected economically reasonable working life of the works.

3 Performance of the product and references to the methods used for its assessment

3.1 Performance of the product

3.1.1 Mechanical resistance and stability (BWR 1)

Requirements with respect to the mechanical resistance and stability of non load bearing parts of the works are not included in this Basic Requirement but are under the Basic Requirement safety in use (BWR 4).

3.1.2 Safety in case of fire (BWR 2)

Essential characteristic	Performance
Reaction to fire	The metal parts of anchor satisfy requirements for class A1 reaction to fire
Resistance to fire	Annex C2

3.1.3 Hygiene, health and the environment (BWR 3)

Regarding dangerous substances there may be requirements (e.g. transposed European legislation and national laws, regulations and administrative provisions) applicable to the products falling within the scope of this European Technical Assessment. In order to meet the provisions of the Regulation (EU) No 305/2011, these requirements need also to be complied with, when and where they apply.

3.1.4 Safety and accessibility in use (BWR 4)

Essential characteristic	Performance
Characteristic resistance for tension and shear loads	Annex C1, C2, C3
Characteristic resistance for bending moment	Annex C1
Displacements under shear and tension loads	Annex C2, C4
Edge distances and spacings	Annex B3, B4

3.1.5 Sustainable use of natural resources (BWR 7)

No performance assessed.

3.1.6 General aspects relating to fitness for use

Durability and serviceability are only ensured if the specifications of intended use according to Annex B1 are kept.

3.2 Methods used for the assessment

The assessment of performance of the anchor for the declared intended use has been made in accordance with the ETAG 020 *“Plastic anchors for multiple use in concrete and masonry for non-structural applications”*.

4 Assessment and verification of constancy of performance (AVCP) system applied, with reference to its legal base

According to the Decision 97/463/EC of the Commission of 27 June 1997 the system 2+ of assessment and verification of constancy of performance (see Annex V to Regulation (EU) No 305/2011) applies.

5 Technical details necessary for the implementation of the AVCP system, as provided in the applicable European Assessment Document (EAD)

Technical details necessary for the implementation of the AVCP system are laid down in the control plan deposited in Instytut Techniki Budowlanej.

For the type testing the results of the tests performed as part of the assessment for the European Technical Assessment shall be used unless there are changes in the production line or plant. In such cases the necessary type testing has to be agreed between Instytut Techniki Budowlanej and the notified body.

Issued in Warsaw on 29/06/2018 by Instytut Techniki Budowlanej

Anna Panek, MSc
Deputy Director of ITB

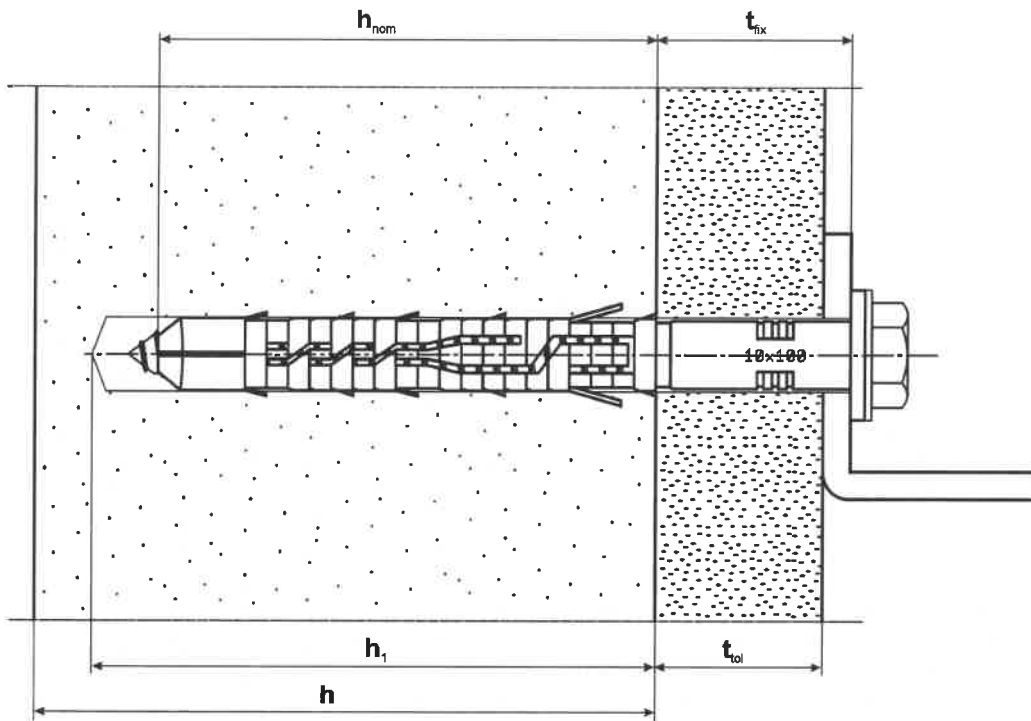

Intended Use

Fixing in concrete and in different types of masonry

Legend

h_{nom} = overall plastic anchor embedment depth in the base material

h_1 = depth of drill hole to deepest point

h = thickness of member (wall)

t_{fix} = t_{tol} + thickness of fixture

t_{tol} = thickness of equalizing layer or non-load-bearing coating

<p>KPR-FAST, KPS-FAST, KPR-STRONG and KPS-STRONG</p>	<p>Annex A1</p>
<p>Product description Intended use</p>	<p>of European Technical Assessment ETA-12/0272</p>

Sleeve KPR

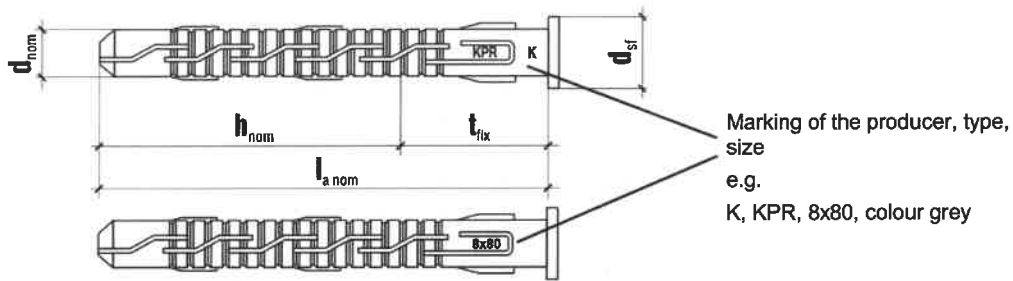

Screw KS

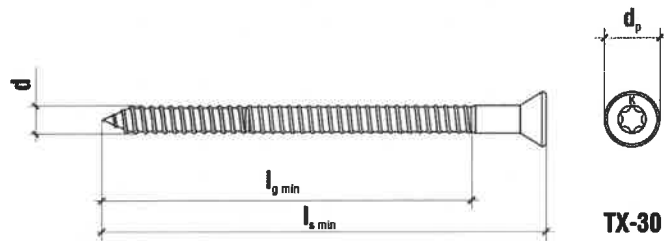

Screw KK

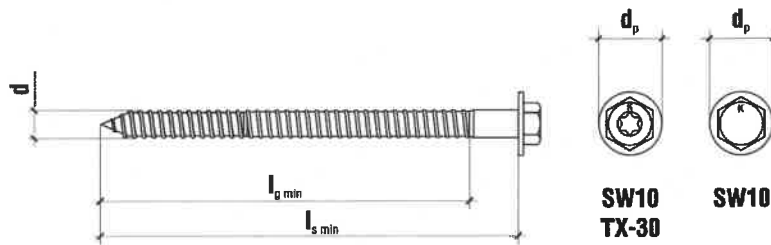

KPR-FAST, KPS-FAST, KPR-STRONG and KPS-STRONG

Product description
KPR-FAST 8/50 and 8/70 anchor

Annex A2
of European
Technical Assessment
ETA-12/0272

Sleeve KPS

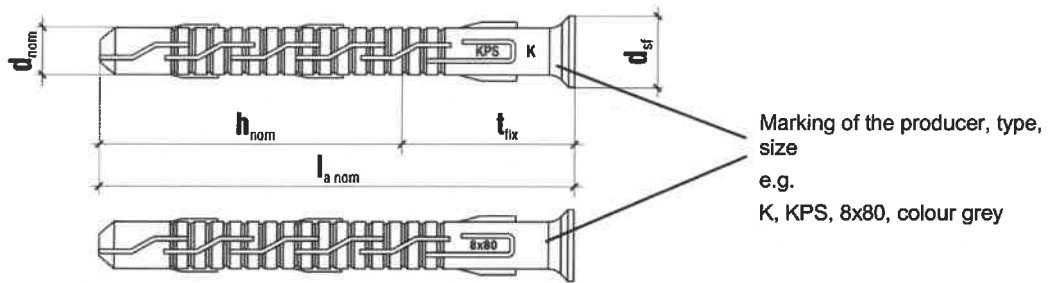

Screw KS

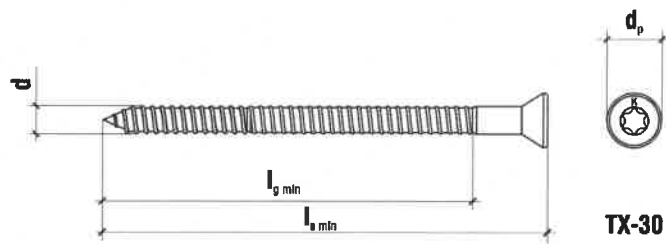

Screw KK

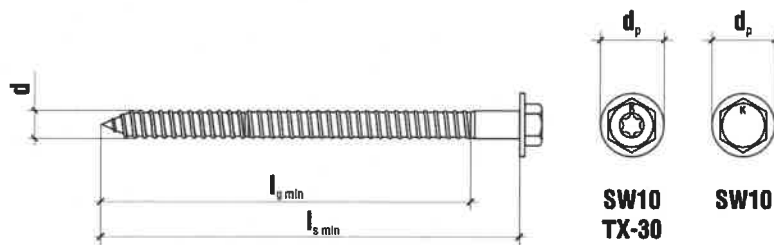

KPR-FAST, KPS-FAST, KPR-STRONG and KPS-STRONG

Product description
KPS-FAST 8/50 and 8/70 anchor

Annex A3
of European
Technical Assessment
ETA-12/0272

Sleeve KPR

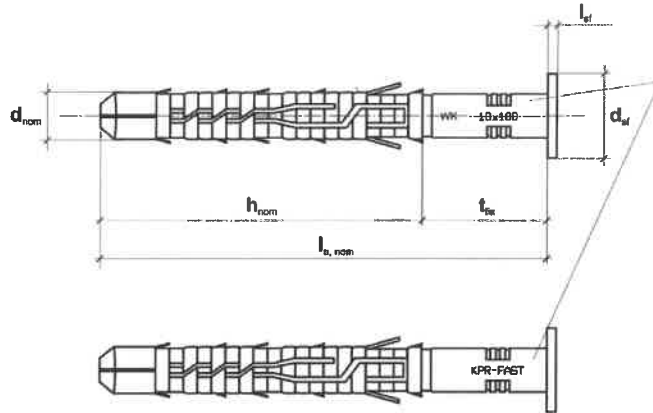

Marking of the producer, type, size

e.g.

WK, KPR-FAST, 10x100, colour red

Screw KSS

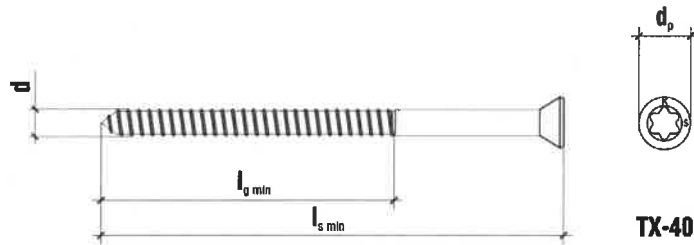

Screw KKS

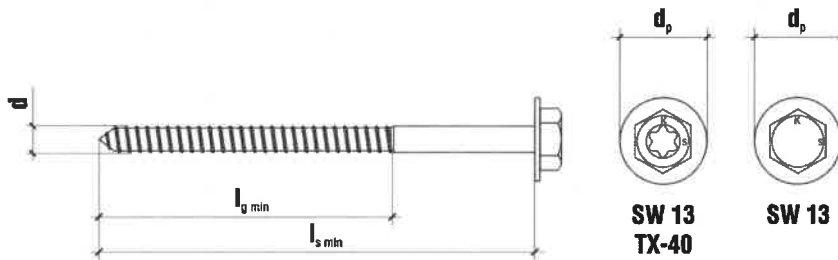

KPR-FAST, KPS-FAST, KPR-STRONG and KPS-STRONG

Product description
KPR-STRONG 10 anchor

Annex A4
of European
Technical Assessment
ETA-12/0272

Sleeve KPS

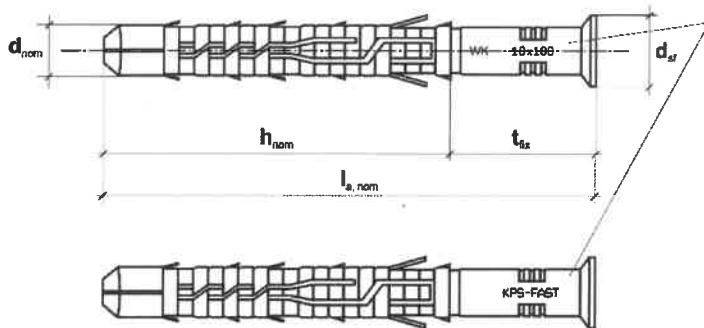

Marking of the producer, type, size

e.g.

WK, KPS-FAST, 10x100, colour red

Screw KSS

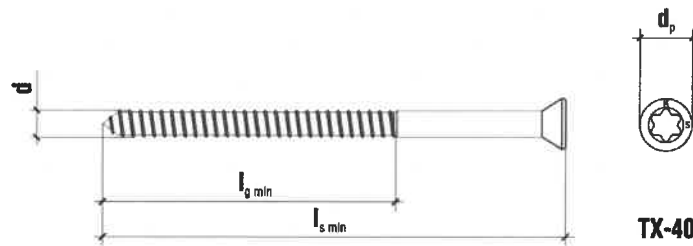

TX-40

Screw KKS

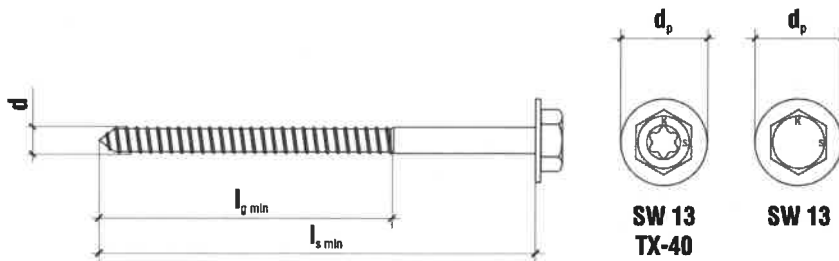

SW 13
TX-40

SW 13

KPR-FAST, KPS-FAST, KPR-STRONG and KPS-STRONG

Product description
KPS-STRONG 10 anchor

Annex A5
of European
Technical Assessment
ETA-12/0272

Sleeve KPR

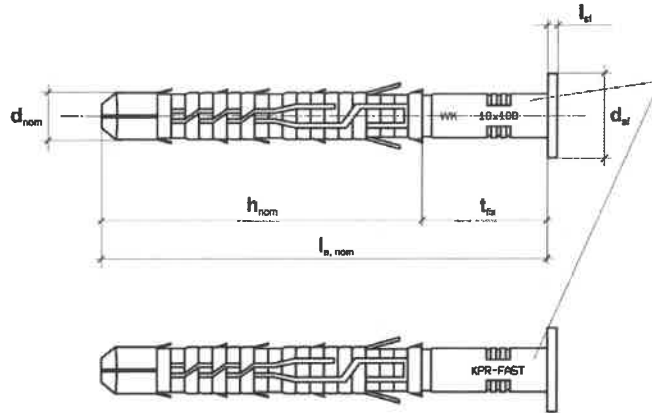

Marking of the producer, type, size

e.g.

WK, KPR-FAST, 10x100, colour grey

Screw KS

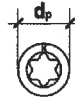
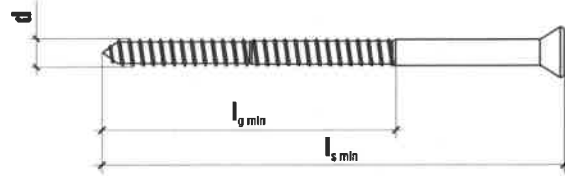

TX-40

Screw KK

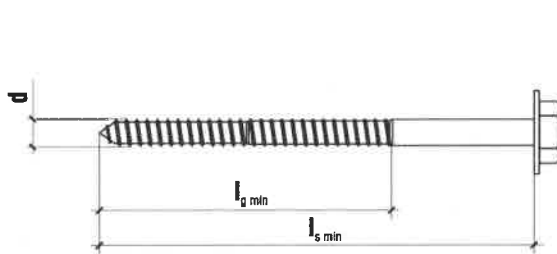

**SW 13
TX-40**

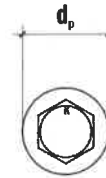

SW 13

KPR-FAST, KPS-FAST, KPR-STRONG and KPS-STRONG

Product description
KPR-FAST 10 anchor

Annex A6
of European
Technical Assessment
ETA-12/0272

Sleeve KPS

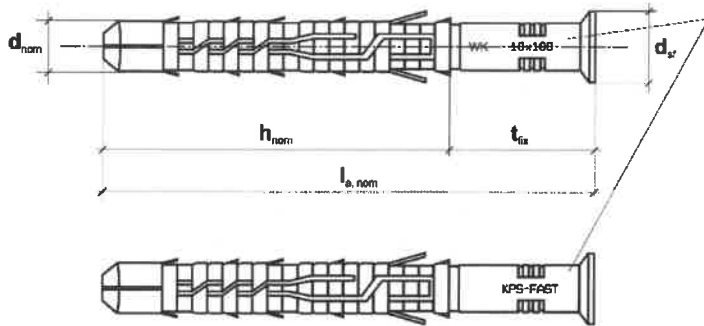

Marking of the producer, type, size
e.g.
WK, KPS-FAST, 10x100, colour grey

Screw KS

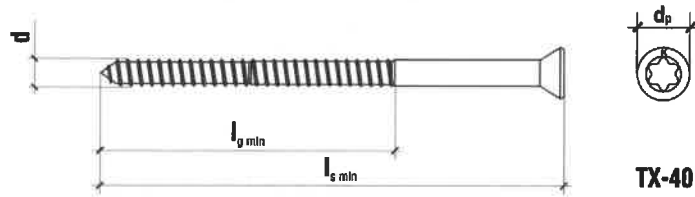

TX-40

Screw KK

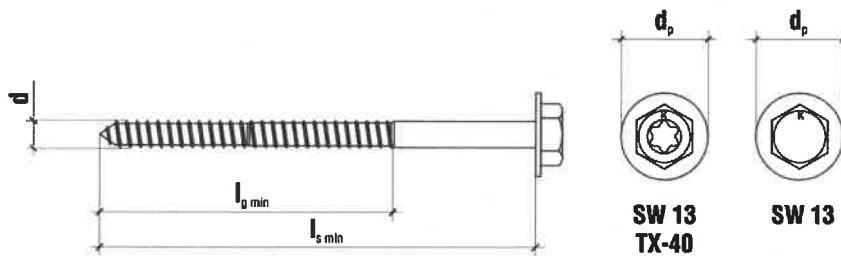

**SW 13
TX-40**

SW 13

KPR-FAST, KPS-FAST, KPR-STRONG and KPS-STRONG

Product description
KPS-FAST 10 anchor

Annex A7
of European
Technical Assessment
ETA-12/0272

Sleeve KPR

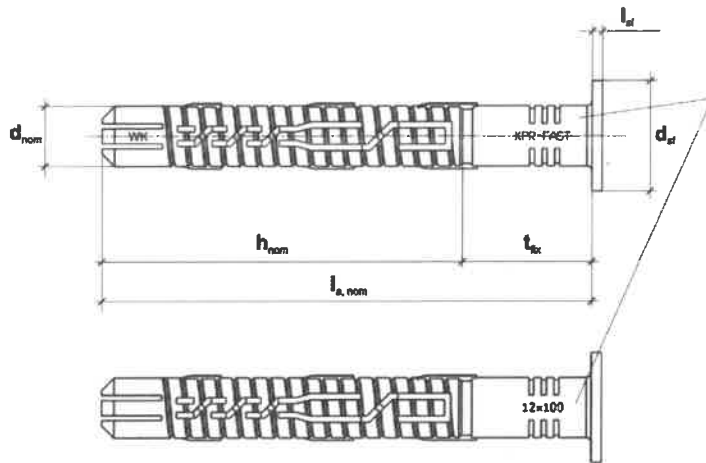

Marking of the producer, type, size

e.g.

WK, KPR-FAST, 12x100, colour grey

Screw KS

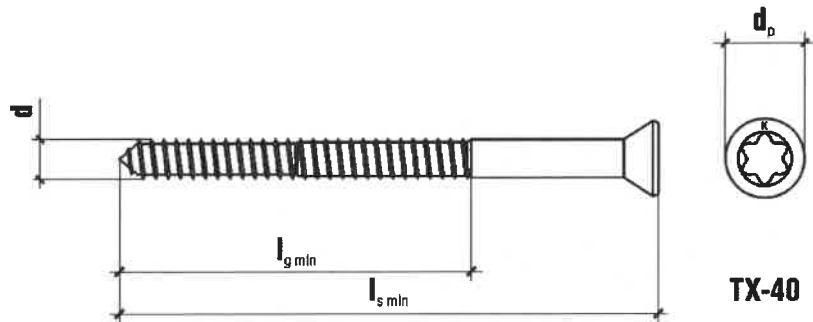

TX-40

Screw KK

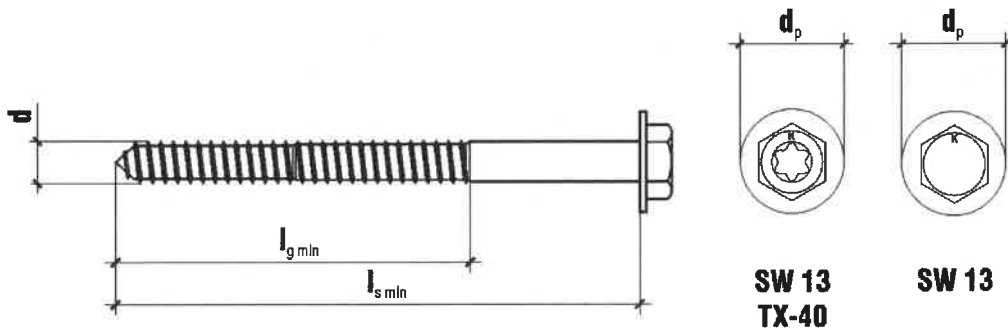

KPR-FAST, KPS-FAST, KPR-STRONG and KPS-STRONG

Product description
KPR-FAST 12 anchor

Annex A8
of European
Technical Assessment
ETA-12/0272

Sleeve KPS

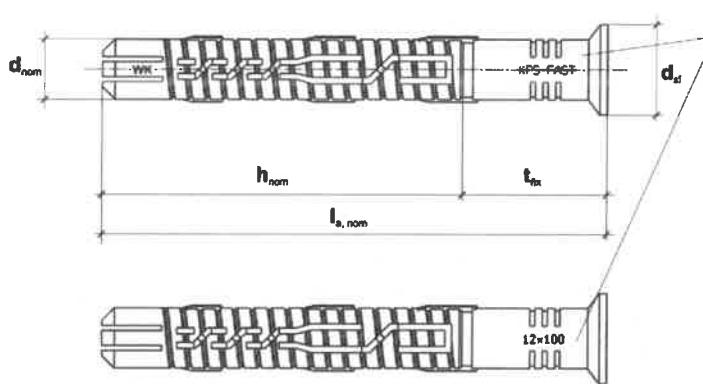

Marking of the producer, type, size

e.g.

WK, KPS-FAST, 12x100, colour grey

Screw KS

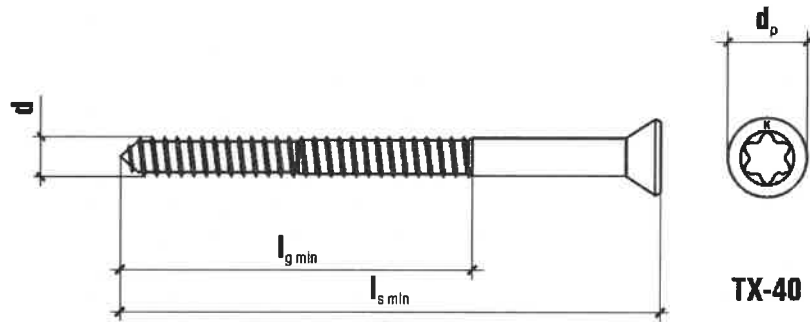

Screw KK

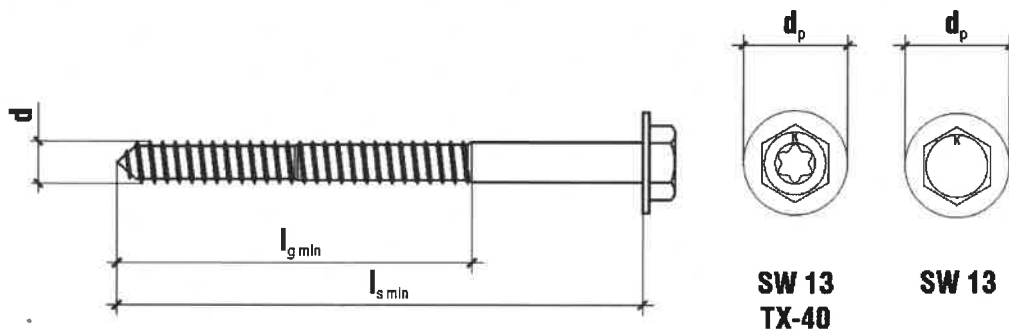

KPR-FAST, KPS-FAST, KPR-STRONG and KPS-STRONG

Product description
KPS-FAST 12 anchor

Annex A9
of European
Technical Assessment
ETA-12/0272

Sleeve KPR

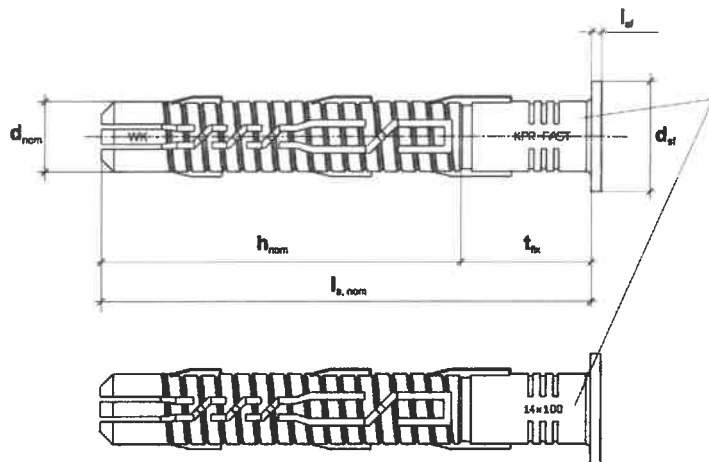

Marking of the producer, type, size
e.g.
WK, KPR-FAST, 14x100, colour grey

Screw KS

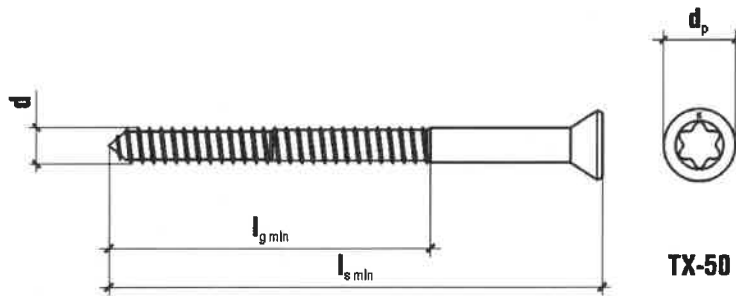

Screw KK

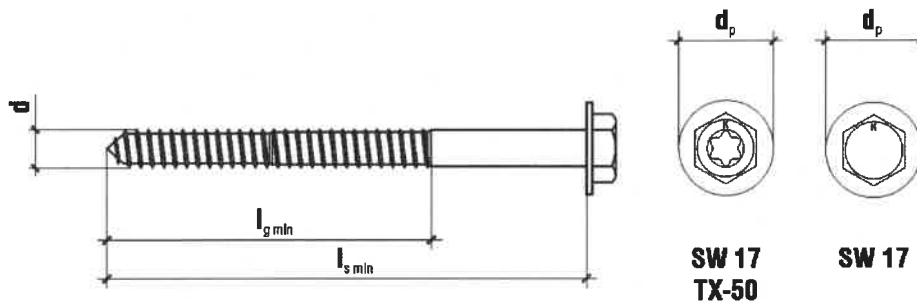

KPR-FAST, KPS-FAST, KPR-STRONG and KPS-STRONG

Product description
KPR-FAST 14 anchor

Annex A10
of European
Technical Assessment
ETA-12/0272

Sleeve KPS

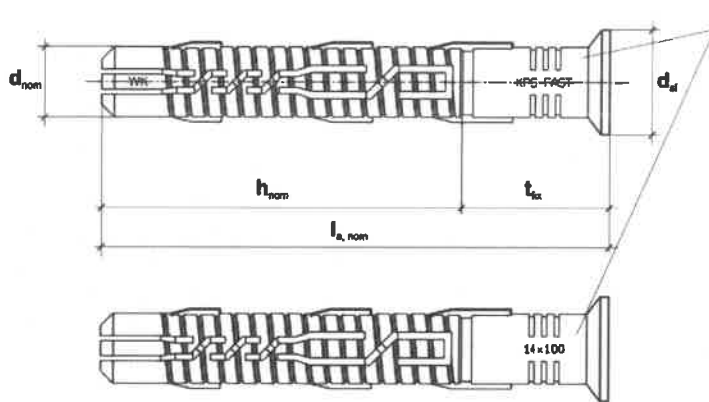

Marking of the producer, type, size

e.g.

WK, KPS-FAST, 14x100, colour grey

Screw KS

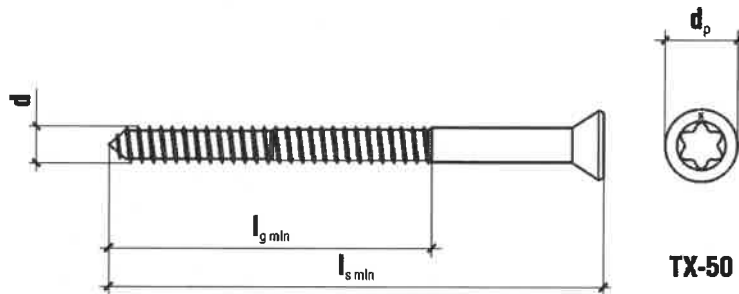

TX-50

Screw KK

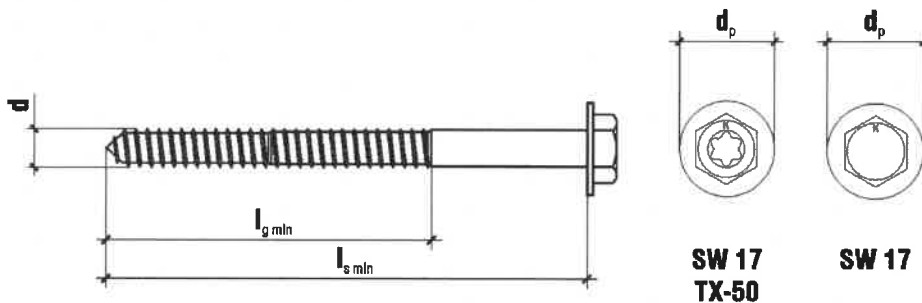

**SW 17
TX-50**

SW 17

KPR-FAST, KPS-FAST, KPR-STRONG and KPS-STRONG

Product description
KPS-FAST 14 anchor

Annex A11
of European
Technical Assessment
ETA-12/0272

Table A1: Anchor types and dimensions [mm]

Anchor type	Anchor sleeve ¹⁾					Screw ¹⁾				
	d _{nom} [mm]	h _{nom} [mm]	d _{sf} [mm]	l _{a, nom} [mm]	l _{sf} [mm]	d [mm]	l _{g, min} [mm]	l _{s, min} [mm]	d _p [mm]	
									KK KKS*	KS KSS*
KPR-FAST 8/50	8	50	15	65-220	2	6,0	75	l _{a, nom} + 5 mm	13	11
KPS-FAST 8/50	8	50	12	65-220	-	6,0	75	l _{a, nom} + 5 mm	13	11
KPR-FAST 8/70	8	70	15	80-220	2	6,0	75	l _{a, nom} + 5 mm	13	11
KPS-FAST 8/70	8	70	12	80-220	-	6,0	75	l _{a, nom} + 5 mm	13	11
KPR-STRONG 10*	10	70	18	80-300	2	7,0	65	l _{a, nom} + 5 mm	18*	14*
KPS-STRONG 10*	10	70	15	80-300	-	7,0	65	l _{a, nom} + 5 mm	18*	14*
KPR-FAST 10	10	70	18	80-300	2	7,0	75	l _{a, nom} + 5 mm	18	14
KPS-FAST 10	10	70	15	80-300	-	7,0	75	l _{a, nom} + 5 mm	18	14
KPR-FAST 12	12	70	18	80-360	2	8,0	75	l _{a, nom} + 5 mm	18	14
KPS-FAST 12	12	70	16	80-360	-	8,0	75	l _{a, nom} + 5 mm	18	14
KPR-FAST 14	14	70	22	80-360	2	10,0	80	l _{a, nom} + 10 mm	22	20
KPS-FAST 14	14	70	22	80-360	-	10,0	80	l _{a, nom} + 10 mm	22	20

1) The anchor (plastic sleeve and special screw) shall only be packaged and supplied as a complete unit

*) With special screw KKS and KSS

KPR-FAST, KPS-FAST, KPR-STRONG and KPS-STRONG

Product description
Anchor types and dimensions

Annex A12
of European
Technical Assessment
ETA-12/0272

Table A2: Materials

Element	Material		
	KPR-FAST 8 KPS-FAST 8 KPR-FAST 10 KPS-FAST 10	KPR-STRONG 10 KPS-STRONG 10	KPR-FAST 12 KPS-FAST 12 KPR-FAST 14 KPS-FAST 14
Anchor sleeve	Polyamid, PA6, colour grey	Polyamid, PA6, colour red	Polyamid, PA6, colour grey
Specific screw	Steel ($f_{y,k} \geq 640$ MPa, $f_{u,k} \geq 800$ MPa)		Steel ($f_{y,k} \geq 320$ MPa, $f_{u,k} \geq 400$ MPa)
	a) Electroplated coatings ≥ 5 μm acc. EN ISO 4042;		
	b) Hot dip galvanised coatings ≥ 40 μm acc. EN ISO 10684;		
	c) Non-electrolytically applied zinc flake coatings ≥ 8 μm acc. EN ISO 10683;		
d) zinc diffusion coating ≥ 30 μm acc. to EN 13811 and EN ISO 17668			
or			
stainless steel grade 1.4301, 1.4306, 1.4307 (AISI 304) or 1.4401, 1.4404, 1.4571 (AISI 316) according to EN 10088 ($f_{y,k} \geq 360$ MPa, $f_{u,k} \geq 600$ MPa)			

KPR-FAST, KPS-FAST, KPR-STRONG and KPS-STRONG**Product description**
Materials**Annex A13**
of European
Technical Assessment
ETA-12/0272

Specification of intended use

Anchorage subject to:

- Static and quasi-static loads.
- Multiple fixing of non-structural applications.

Base materials:

- Reinforced or unreinforced normal weight concrete with strength classes \geq C12/15 (use category a), according to EN 206.
- Solid masonry (use category b), according to Annex C3.
Note: The characteristic resistance is also valid for larger sizes and larger compressive strength of the masonry unit.
- Hollow or perforated masonry (use category c), according to Annex C3.
- Autoclaved aerated concrete (use category d), according to Annex C3.
- Mortar strength class of the masonry M2.5 at minimum according to EN 998-2.
- For other base materials of the use categories a, b, c and d the characteristic resistance of the anchor may be determined by job site tests according to ETAG 020, edition March 2012, Annex B.

Temperature range:

-20°C to +80°C (max. short term temperature +80°C and max. long term temperature +50°C).

Use conditions (environmental conditions):

- Structures subject to dry internal conditions (zinc coated steel, stainless steel).
- Structures subject to external atmospheric exposure, if anchor is not directly subjected to this exposure, i.e. external cladding elements screen the anchor, and the head of screw is additionally protected by permanently elastic coating which precludes corrosion from occurring and prevents moisture from entering into plastic sleeve (zinc coated steel).
- Structures subject to external atmospheric exposure including industrial and marine environment (stainless steel).
- Structures subject to permanently damp internal condition, if no particular aggressive conditions exist (stainless steel).

Note: Particular aggressive conditions are e.g. permanent, alternating immersion in seawater or the splash zone of seawater, chloride atmosphere of indoor swimming pools or atmosphere with extreme chemical pollution (e.g. in desulphurization plants or road tunnels where de-icing materials are used).

Design:

- The anchorages are designed in accordance with the ETAG 020, edition March 2012, Annex C under the responsibility of an engineer experienced in anchorages and masonry work.
- Verifiable calculation notes and drawings shall be prepared taking account the loads to be anchored, the nature and strength of the base materials and the dimensions of the anchorage members as well as of the relevant tolerances. The position of the anchor is indicated on the design drawings.
- Fasteners are only to be used for multiple fixings for non-structural application, according to ETAG 020, edition March 2012.

Installation:

- Hole shall be drilled by the drill modes given in Annexes C2 and C3 for use categories a, b, c and d; the influence of other drilling methods may be determined by job side tests according to ETAG 020, edition March 2012, Annex B.
- Anchor installation shall be carried out by appropriately qualified personnel and under the supervision of the person responsible for technical matters of the site.
- Installation shall be executed in temperature from -20°C to +40°C.
- Exposure to UV due to solar radiation of the anchor not protected by the mortar shall not exceed \leq 6 weeks.

KPR-FAST, KPS-FAST, KPR-STRONG and KPS-STRONG	Annex B1 of European Technical Assessment ETA-12/0272
Intended use Specifications	

Table B1: Installation parameters

Anchor type	KPR-FAST KPS-FAST 8/50	KPR-FAST KPS-FAST 8/70	KPR- STRONG KPS- STRONG 10	KPR-FAST KPS-FAST 10	KPR-FAST KPS-FAST 12	KPR-FAST KPS-FAST 14
Drill hole diameter d_o [mm]	8	8	10	10	12	14
Cutting diameter of drill bit $d_{cut} \leq$ [mm]	8,45	8,45	10,45	10,45	12,45	14,45
Depth of drill hole to deepest point $h_1 \geq$ [mm]	60	80	80	80	80	85
Overall plastic anchor embedment depth in the base material $h_{nom} \geq$ [mm]	50	70	70	70	70	70
Diameter of clearance hole in the fixture $d_f \leq$ [mm]	8,5-9,0	8,5-9,0	10,5-11,0	10,5-11,0	12,5-13,0	14,5-15,0
Thickness of fixture – minimum $t_{fix, min} \geq$ [mm]	1	1	1	1	1	1
Thickness of fixture – maximum $t_{fix, max} \leq$ [mm]	170	150	230	230	290	290
Installation temperature °C	-20 to +40	-20 to +40	-20 to +40	-20 to +40	-20 to +40	-20 to +40
Torque moment for concrete and masonry T_{inst} [Nm]	7	7	15	15	30	50
Torque moment for AAC T_{inst} [Nm]	3	3	5	5	13	18

KPR-FAST, KPS-FAST, KPR-STRONG and KPS-STRONG

Intended use
Installation parameters

Annex B2
of European
Technical Assessment
ETA-12/0272

Table B2: Minimum thickness of member, edge distance and anchor spacing in concrete

Anchor diameter	Base material	h_{min} [mm]	$C_{cr, N}$ [mm]	C_{min} [mm]	S_{min} [mm]
$\phi 8$	Concrete \geq C16/20	100	70 ¹⁾ / 100 ²⁾	50 ¹⁾ / 60 ²⁾	50 ¹⁾ / 60 ²⁾
	Concrete \geq C12/15	100	100 ¹⁾ / 140 ²⁾	70 ¹⁾ / 80 ²⁾	70 ¹⁾ / 80 ²⁾
$\phi 10$	Concrete \geq C16/20	100	100	60	60
	Concrete \geq C12/15	100	140	80	80
$\phi 12$	Concrete \geq C16/20	100	100	100	100
	Concrete \geq C12/15	100	140	140	140
$\phi 14$	Concrete \geq C16/20	100	100	100	100
	Concrete \geq C12/15	100	140	140	140

¹⁾ for KPR-FAST 80/50 and KPS-FAST 80/50

²⁾ for KPR-FAST 80/70 and KPS-FAST 80/70

Scheme of distances and spacing in concrete

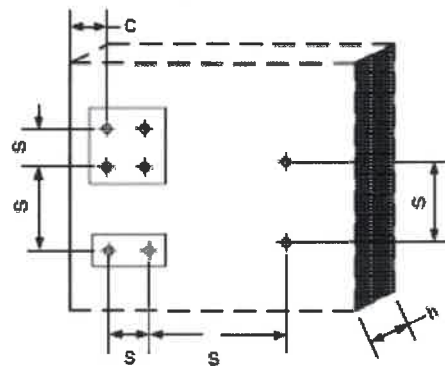

KPR-FAST, KPS-FAST, KPR-STRONG and KPS-STRONG

Intended use
Minimum thickness of member, edge distance and anchor spacing in concrete

Annex B3
of European
Technical Assessment
ETA-12/0272

Table B3: Minimum thickness of member, edge distance and anchor spacing in masonry

Anchor diameter	Base material	Type of element	Single anchor			Anchor group ¹⁾	
			h_{min} [mm]	C_{min} [mm]	S_{min} [mm]	$S_{min1}^{2)}$ [mm]	$S_{min2}^{3)}$ [mm]
$\phi 8$	masonry made of ceramic, calcium silicate and lightweight aggregate concrete elements	solid	120	100	100	100	200
		perforated or hollow	180	100	100	100	200
	masonry made of autoclaved aerated concrete elements	–	100	100	100	100	200
$\phi 10$	masonry made of ceramic, calcium silicate and lightweight aggregate concrete elements	solid	120	100	100	100	200
		perforated or hollow	180	100	100	100	200
	masonry made of autoclaved aerated concrete elements	–	100	100	100	100	200
$\phi 12$	masonry made of ceramic, calcium silicate and lightweight aggregate concrete elements	solid	120	100	100	100	200
		perforated or hollow	180	100	100	100	200
	masonry made of autoclaved aerated concrete elements	–	100	100	100	100	200
$\phi 14$	masonry made of ceramic, calcium silicate and lightweight aggregate concrete elements	solid	120	100	100	100	200
		perforated or hollow	180	100	100	100	200
	masonry made of autoclaved aerated concrete elements	–	100	100	100	100	200

¹⁾ The design method valid for single anchor and anchor groups with two or four anchors

²⁾ In direction perpendicular to free edge

³⁾ In direction parallel to free edge

Scheme of distances and spacing in masonry

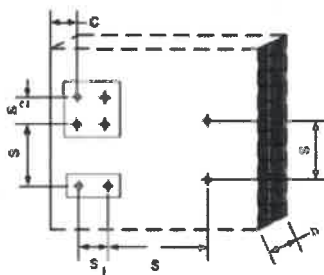

KPR-FAST, KPS-FAST, KPR-STRONG and KPS-STRONG

Intended use
Minimum thickness of member, edge distance and anchor spacing in masonry

Annex B4
of European
Technical Assessment
ETA-12/0272

	<p>Drill the hole considering the drilling method and clean the hole of drilling dust</p>
	<p>Insert the plastic sleeve and special screw into the hole through the fixture by slight hammer blows</p>
	<p>Screw-in the special screw until the head of the screw touches the sleeve; the anchor is correct mounted, if there is no turn-through of the plastic sleeve in the drill hole and if slightly move on turning of the screw is impossible</p>
<p>KPR-FAST, KPS-FAST, KPR-STRONG and KPS-STRONG</p>	
<p>Intended use Installation instruction</p>	<p>Annex B5 of European Technical Assessment ETA-12/0272</p>

Table C1: Characteristic bending resistance of the specific screw in concrete and masonry

Anchor diameter	$\phi 8$	$\phi 10$	$\phi 12$	$\phi 14$
Characteristic bending resistance $M_{Rk,s}$ [Nm]	14,0 ¹⁾ (10,5) ²⁾	22,5 ¹⁾ (16,8) ²⁾	16,2 ¹⁾ (24,2) ²⁾	34,4 ¹⁾ (51,5) ²⁾
Partial safety factor γ_{Ms} ³⁾	1,25 ¹⁾ (1,67) ²⁾	1,25 ¹⁾ (1,67) ²⁾	1,25 ¹⁾ (1,67) ²⁾	1,25 ¹⁾ (1,67) ²⁾

¹⁾ galvanised steel²⁾ stainless steel³⁾ in absence of other national regulations**Table C2: Characteristic resistance of the screw for use in concrete, failure of expansion element (specific screw)**

Anchor diameter		$\phi 8$	$\phi 10$	$\phi 12$	$\phi 14$
Characteristic tension resistance	$N_{Rk,s}$ [kN]	17,6 ¹⁾ (13,2) ²⁾	24,2 ¹⁾ (18,1) ²⁾	15,4 ¹⁾ (23,1) ²⁾	25,4 ¹⁾ (38,2) ²⁾
Partial safety factor	γ_{Ms} ³⁾	1,50 ¹⁾ (2,00) ²⁾	1,50 ¹⁾ (2,00) ²⁾	1,50 ¹⁾ (2,00) ²⁾	1,50 ¹⁾ (2,00) ²⁾
Characteristic shear resistance	$V_{Rk,s}$ [kN]	6,2 ¹⁾ (6,1) ²⁾	12,1 ¹⁾ (9,1) ²⁾	7,70 ¹⁾ (11,5) ²⁾	12,7 ¹⁾ (19,1) ²⁾
Partial safety factor	γ_{Ms} ³⁾	1,25 ¹⁾ (1,67) ²⁾	1,25 ¹⁾ (1,67) ²⁾	1,25 ¹⁾ (1,67) ²⁾	1,25 ¹⁾ (1,67) ²⁾

¹⁾ galvanised steel²⁾ stainless steel³⁾ in absence of other national regulations**KPR-FAST, KPS-FAST, KPR-STRONG and KPS-STRONG****Performances**
Characteristic resistance of the screw**Annex C1**
of European
Technical Assessment
ETA-12/0272

Table C3: Characteristic resistance for use in concrete, pull-out failure (plastic sleeve); hammer drilling

Anchor diameter		φ8	φ10	φ12	φ14
Temperature range		-20 to +80			
Concrete ≥ C16/20					
Characteristic resistance	$N_{Rk,p}$ [kN]	3,5 ¹⁾ / 4,5 ²⁾	4,0 ³⁾ / 6,0 ⁴⁾	5,0	8,0
Partial safety factor	γ_{Mc} ⁵⁾	1,8			
Concrete C12/15					
Characteristic resistance	$N_{Rk,p}$ [kN]	2,5 ¹⁾ / 3,0 ²⁾	3,0 ³⁾ / 4,5 ⁴⁾	3,5	5,5
Partial safety factor	γ_{Mc} ⁵⁾	1,8			

¹⁾ KPR-FAST 8/50, KPS-FAST 8/50

²⁾ KPR-FAST 8/70, KPS-FAST 8/70

³⁾ KPR-FAST 10, KPS-FAST 10

⁴⁾ KPR-STRONG 10, KPS-STRONG 10

⁵⁾ In absence of other national regulations

Table C4: Displacements under tension and shear loading in concrete ^{5), 6)}

Anchor diameter	Tension load			Shear load		
	F [kN]	δ_{NO} [mm]	$\delta_{N=}$ [mm]	F [kN]	δ_{NO} [mm]	$\delta_{N=}$ [mm]
φ8	1,40 ¹⁾ /1,78 ²⁾	0,34 ¹⁾ /0,29 ²⁾	0,68 ¹⁾ /0,58 ²⁾	3,70	3,16	4,74
φ10	1,60 ³⁾ /2,38 ⁴⁾	0,26 ³⁾ /0,35 ⁴⁾	0,73 ³⁾ /0,70 ⁴⁾	7,20	3,60	5,39
φ12	1,98	0,37	0,55	8,29	3,83	5,74
φ14	3,00	0,31	0,86	12,91	5,77	8,65

¹⁾ KPR-FAST 8/50, KPS-FAST 8/50

²⁾ KPR-FAST 8/70, KPS-FAST 8/70

³⁾ KPR-FAST 10, KPS-FAST 10

⁴⁾ KPR-STRONG 10, KPS-STRONG 10

⁵⁾ Valid for all ranges of temperatures

⁶⁾ Intermediate values by linear interpolation

Table C5: Characteristic values F_{Rk} in any load direction under fire exposure in concrete C20/25 to C50/60, no permanent centric tension load and shear load with lever arm



Anchor type	Fire resistance class	F_{Rk} , kN
KPR FAST 10, KPR-STRONG 10 KPS FAST 10, KPS-STRONG 10	R 90	≤ 0,8

KPR-FAST, KPS-FAST, KPR-STRONG and KPS-STRONG

Performances
Characteristic resistance in concrete (use category a),
displacements in concrete

Annex C2
of European
Technical Assessment
ETA-12/0272

Table C6: Characteristic resistance F_{Rk} [kN] in masonry







Anchor type / base material	Bulk density class [kg/dm ³]	Compressive strength class [N/mm ²]	Picture	Drill method	$F_{Rk}^{1)}$ [kN]
KPR-FAST 8/50 and KPS-FAST 8/50					
Clay brick German ^{1), 6)}	≥ 2,00	≥ 10		hammer	2,5
Clay brick German ^{1), 6)}	≥ 2,00	≥ 20		hammer	3,0
Calcium silicate brick ^{2), 7)}	≥ 2,00	≥ 20		hammer	3,0

KPR-FAST, KPS-FAST, KPR-STRONG and KPS-STRONG

Performances
Characteristic resistance in masonry (use category b, c and d)

Annex C3
of European
Technical Assessment
ETA-12/0272

Extension of Table C6









Anchor type / base material	Bulk density class [kg/dm ³]	Compressive strength class [N/mm ²]	Picture	Drill method	F _{Rk} ⁽¹⁾ [kN]
KPR-FAST 8/70 and KPS-FAST 8/70					
Clay brick German ^(1), 6)	≥ 2,00	≥ 10		hammer	2,5
Clay brick German ^(1), 6)	≥ 2,00	≥ 20		hammer	3,0
Calcium silicate brick ^{2), 7)}	≥ 2,00	≥ 20		hammer	3,0
Porotherm 25P + W ⁽¹⁾	≥ 0,80	≥ 15		rotary drilling only	1,2
MAX 250 ⁽¹⁾	≥ 0,80	≥ 15		rotary drilling only	1,2
Calcium silicate hollow block ^(2), 9)	≥ 1,60	≥ 12		rotary drilling only	2,5
Hollow lightweight aggregate concrete element ^(3), 10)	≥ 0,80	≥ 2		rotary drilling only	1,5
Autoclaved aerated concrete element AAC 2 ⁽⁴⁾	≥ 0,35	≥ 2	—	rotary drilling only	0,6
Autoclaved aerated concrete element AAC 7 ⁽⁴⁾	≥ 0,65	≥ 6,5	—	rotary drilling only	2,0

KPR-FAST, KPS-FAST, KPR-STRONG and KPS-STRONG

Performances
Characteristic resistance in masonry (use category b, c and d)

Annex C3
of European
Technical Assessment
ETA-12/0272

Extension of Table C6



Anchor type / base material	Bulk density class [kg/dm ³]	Compressive strength class [N/mm ²]	Picture	Drill method	F _{Rk} ⁽¹¹⁾ [kN]
KPR-FAST 10 and KPS-FAST 10					
Clay brick Polish ^(1), 5)	≥ 1,70	≥ 10		hammer	2,5
Clay brick Polish ^(1), 5)	≥ 1,70	≥ 20		hammer	3,5
Clay brick German ^(1), 6)	≥ 2,00	≥ 10		hammer	2,5
Clay brick German ^(1), 6)	≥ 2,00	≥ 20		hammer	3,5
Calcium silicate brick ^(2), 7)	≥ 2,00	≥ 20		hammer	3,5
Porotherm 25P + W ⁽¹⁾	≥ 0,80	≥ 15		rotary drilling only	0,9
MAX 250 ⁽¹⁾	≥ 0,80	≥ 15		rotary drilling only	0,9
Perforated ceramic brick ^(1), 8)	≥ 1,20	≥ 12		rotary drilling only	2,0
Calcium silicate hollow block ^(2), 9)	≥ 1,60	≥ 12		rotary drilling only	2,5
Hollow lightweight aggregate concrete element ^(3), 10)	≥ 0,80	≥ 2		rotary drilling only	1,5
Autoclaved aerated concrete element AAC 2 ⁽⁴⁾	≥ 0,35	≥ 2	—	rotary drilling only	0,6
Autoclaved aerated concrete element AAC 7 ⁽⁴⁾	≥ 0,65	≥ 6,5	—	rotary drilling only	1,5

KPR-FAST, KPS-FAST, KPR-STRONG and KPS-STRONG

Performances
Characteristic resistance in masonry (use category b, c and d)

Annex C3
of European
Technical Assessment
ETA-12/0272

Extension of Table C6







Anchor type / base material	Bulk density class [kg/dm ³]	Compressive strength class [N/mm ²]	Picture	Drill method	F _{RK} ¹¹⁾ [kN]
KPR-STRONG 10 and KPS-STRONG 10					
Clay brick German ^{1), 6)}	≥ 2,00	≥ 10		hammer	2,5
Clay brick German ^{1), 6)}	≥ 2,00	≥ 20		hammer	3,5
Calcium silicate brick ^{2), 7)}	≥ 2,00	≥ 20		hammer	3,5

KPR-FAST, KPS-FAST, KPR-STRONG and KPS-STRONG

Performances
Characteristic resistance in masonry (use category b, c and d)

Annex C3
of European
Technical Assessment
ETA-12/0272

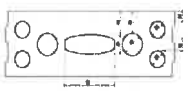
Extension of Table C6







Anchor type / base material	Bulk density class [kg/dm ³]	Compressive strength class [N/mm ²]	Picture	Drill method	F _{Rk} ¹¹⁾ [kN]
KPR-FAST 12 and KPS-FAST 12					
Clay brick Polish ^{1), 5)}	≥ 1,70	≥ 10		hammer	2,5
Clay brick Polish ^{1), 5)}	≥ 1,70	≥ 20		hammer	3,5
Clay brick German ^{1), 6)}	≥ 2,00	≥ 10		hammer	2,5
Clay brick German ^{1), 6)}	≥ 2,00	≥ 20		hammer	3,5
Calcium silicate brick ^{2), 7)}	≥ 2,00	≥ 20		hammer	3,5
Perforated ceramic brick ^{1), 8)}	≥ 1,20	≥ 12		rotary drilling only	2,0
Calcium silicate hollow block ^{2), 9)}	≥ 1,60	≥ 12		rotary drilling only	3,0
Hollow lightweight aggregate concrete element ^{3), 10)}	≥ 0,80	≥ 2		rotary drilling only	1,5
Autoclaved aerated concrete element AAC 2 ⁴⁾	≥ 0,35	≥ 2	—	rotary drilling only	0,75
Autoclaved aerated concrete element AAC 7 ⁴⁾	≥ 0,65	≥ 6,5	—	rotary drilling only	3,0

KPR-FAST, KPS-FAST, KPR-STRONG and KPS-STRONG

Performances
Characteristic resistance in masonry (use category b, c and d)

Annex C3
of European
Technical Assessment
ETA-12/0272

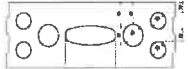
Extension of Table C6

Anchor type / base material	Bulk density class [kg/dm ³]	Compressive strength class [N/mm ²]	Picture	Drill method	F _{Rk} ¹¹⁾ [kN]
KPR-FAST 14 and KPS-FAST 14					
Clay brick Polish ^{1), 5)}	≥ 1,70	≥ 10		hammer	3,0
Clay brick Polish ^{1), 5)}	≥ 1,70	≥ 20		hammer	4,0
Clay brick German ^{1), 6)}	≥ 2,00	≥ 10		hammer	3,0
Clay brick German ^{1), 6)}	≥ 2,00	≥ 20		hammer	4,0
Calcium silicate brick ^{2), 7)}	≥ 2,00	≥ 20		hammer	4,0
Perforated ceramic brick ^{1), 8)}	≥ 1,20	≥ 12		rotary drilling only	2,0
Calcium silicate hollow block ^{2), 9)}	≥ 1,60	≥ 12		rotary drilling only	3,5
Hollow lightweight aggregate concrete element ^{3), 10)}	≥ 0,80	≥ 2		rotary drilling only	2,0
Autoclaved aerated concrete element AAC 2 ⁴⁾	≥ 0,35	≥ 2	—	rotary drilling only	0,9
Autoclaved aerated concrete element AAC 7 ⁴⁾	≥ 0,65	≥ 6,5	—	rotary drilling only	3,0
Partial safety factor γ_{Mm} ¹²⁾	2,5 / 2,0				

1) According to EN 771-1

2) According to EN 771-2

3) According to EN 771-3

4) According to EN 771-4

5) Polish clay brick

6) German clay brick MZ Rd 2.0/20

7) For example Kalksandstein KS NF 20-2.0 Vollstein according to DIN 106

8) For example HLZ Rd1 1.2/12 according to DIN 105

9) For example KSL-R(P)8DF Lochstein according to DIN 106

10) For example Hbl 2/0.8 Leichtbetonhohlstein according to DIN V 18 151-100

11) Characteristic resistance F_{Rk} for tension, shear or combined tension and shear loading.The characteristic resistance is valid for single plastic anchor or for a group of two or four plastic anchors with a spacing equal or larger than the minimum spacing s_{min} according to table B3 (Annex B4).12) Partial safety factor for use in masonry $\gamma_{Mm} = 2,5$ and partial safety factor for use in autoclaved aerated concrete $\gamma_{MAAC} = 2,0$ in absence of other national regulations

KPR-FAST, KPS-FAST, KPR-STRONG and KPS-STRONG

Performances
Characteristic resistance in masonry (use category b, c and d)

Annex C3
of European
Technical Assessment
ETA-12/0272

Table C7: Displacements under tension and shear loading in masonry

Anchor type	Base material	Tension load			Shear load		
		F [kN]	δ_{NO} [mm]	$\delta_{N\infty}$ [mm]	F [kN]	δ_{NO} [mm]	$\delta_{N\infty}$ [mm]
KPR-FAST 8/50 and KPS-FAST 8/50	Clay brick German ^{1), 6)}	0,86	1,71	3,42	0,86	1,71	3,42
	Calcium silicate brick ^{3), 7)}	0,86	0,19	0,38	0,86	0,19	0,38
KPR-FAST 8/70 and KPS-FAST 8/70	Clay brick German ^{1), 6)}	0,86	0,35	0,70	0,86	0,35	0,70
	Calcium silicate brick ^{2), 7)}	0,86	0,20	0,40	0,86	0,20	0,40
	Porotherm 25P + W ^{1), 8)}	0,34	0,23	0,46	0,34	0,23	0,46
	MAX 250 ¹⁾	0,34	0,23	0,46	0,34	0,23	0,46
	Calcium silicate hollow block ^{2), 9)}	0,71	0,31	0,62	0,71	0,31	0,62
	Hollow lightweight aggregate concrete element ^{3), 10)}	0,43	1,10	2,20	0,57	1,10	2,20
	Autoclaved aerated concrete element AAC 2 ⁴⁾	0,21	0,42	0,84	0,21	0,42	0,84
Autoclaved aerated concrete element AAC 7 ⁴⁾	0,71	0,30	0,60	0,71	0,30	0,60	

KPR-FAST, KPS-FAST, KPR-STRONG and KPS-STRONG**Performances**
Displacements in masonry**Annex C4**
of European
Technical Assessment
ETA-12/0272

Extension of Table C7

Anchor type	Base material	Tension load			Shear load		
		F [kN]	δ_{NO} [mm]	$\delta_{N^{\infty}}$ [mm]	F [kN]	δ_{NO} [mm]	$\delta_{N^{\infty}}$ [mm]
KPR-FAST 10 and KPS-FAST 10	Clay brick Polish ^{1), 5)}	1,00	0,20	0,40	1,00	0,83	1,25
	Clay brick German ^{1), 6)}	1,00	1,07	2,13	1,00	0,83	1,25
	Calcium silicate brick ^{3), 7)}	1,00	0,09	0,18	1,00	0,83	1,25
	Porotherm 25P + W ¹⁾	0,30	0,73	1,46	0,26	0,51	0,77
	MAX 250 ¹⁾	0,30	0,73	1,46	0,26	0,51	0,77
	Perforated ceramic brick ^{1), 8)}	0,60	1,38	2,75	0,57	1,14	1,71
	Calcium silicate hollow block ^{2), 9)}	0,70	0,55	1,09	0,71	1,43	2,14
	Hollow lightweight aggregate concrete element ^{3), 10)}	0,43	1,35	2,70	0,57	1,14	1,71
	Autoclaved aerated concrete element AAC 2 ⁴⁾	0,20	0,15	0,29	0,21	0,43	0,64
	Autoclaved aerated concrete element AAC 7 ⁴⁾	0,50	0,02	0,04	0,54	1,07	1,61
KPR-STRONG 10 and KPS-STRONG 10	Clay brick German ^{1), 6)}	1,00	1,10	2,20	1,00	0,83	1,25
	Calcium silicate brick ^{2), 7)}	1,00	0,15	0,30	1,00	0,83	1,25

KPR-FAST, KPS-FAST, KPR-STRONG and KPS-STRONG**Performances**
Displacements in masonry**Annex C4**
of European
Technical Assessment
ETA-12/0272

Extension of Table C7

Anchor type	Base material	Tension load			Shear load		
		F [kN]	δ_{NO} [mm]	δ_{N^∞} [mm]	F [kN]	δ_{NO} [mm]	δ_{N^∞} [mm]
KPR-FAST 12 and KPS-FAST 12	Clay brick Polish ^{1), 5)}	1,00	0,36	0,72	1,00	0,83	1,25
	Clay brick German ^{1), 6)}	1,00	0,27	0,54	1,00	0,83	1,25
	Calcium silicate brick ^{2), 7)}	1,00	0,28	0,56	1,00	0,83	1,25
	Perforated ceramic brick ^{1), 8)}	0,57	0,72	1,44	0,57	1,14	1,71
	Calcium silicate hollow block ^{2), 9)}	0,86	0,43	0,86	0,86	1,71	2,57
	Hollow lightweight aggregate concrete element ^{3), 10)}	0,43	0,06	0,12	0,57	1,14	1,71
	Autoclaved aerated concrete element AAC 2 ⁴⁾	0,27	0,39	0,78	0,27	0,54	0,80
	Autoclaved aerated concrete element AAC 7 ⁴⁾	1,07	0,36	0,72	1,07	2,14	3,21
KPR-FAST 14 and KPS-FAST 14	Clay brick Polish ^{1), 5)}	1,14	0,28	0,56	1,14	0,95	1,43
	Clay brick German ^{1), 6)}	1,14	0,27	0,54	1,14	0,95	1,43
	Calcium silicate brick ^{2), 7)}	1,14	0,09	0,18	1,14	0,95	1,43
	Perforated ceramic brick ^{1), 8)}	0,57	0,13	0,26	0,57	1,14	1,71
	Calcium silicate hollow block ^{2), 9)}	1,00	0,16	0,32	1,00	2,00	3,00
	Hollow lightweight aggregate concrete element ^{3), 10)}	0,57	0,09	0,18	0,57	1,14	1,71
	Autoclaved aerated concrete element AAC 2 ⁴⁾	0,32	0,39	0,78	0,32	0,64	0,96
	Autoclaved aerated concrete element AAC 7 ⁴⁾	1,07	0,17	0,34	1,07	2,14	3,21

¹⁾ According to EN 771-1

²⁾ According to EN 771-2

³⁾ According to EN 771-3

⁴⁾ According to EN 771-4

⁵⁾ Polish clay brick

⁶⁾ German clay brick MZ Rd 2.0/20

⁷⁾ For example Kalksandstein KS NF 20-2.0

⁸⁾ For example HLZ Rd1 1.2/12 according to DIN 105

⁹⁾ For example KSL-R(P)8DF Lochstein according to DIN 106

¹⁰⁾ For example Hbl 2/0,8 Leichtbetonhohlstein according to DINV 18 151-100

KPR-FAST, KPS-FAST, KPR-STRONG and KPS-STRONG

Performances
Displacements in masonry

Annex C4
of European
Technical Assessment
ETA-12/0272

